

# ARCAPRO® Positioner

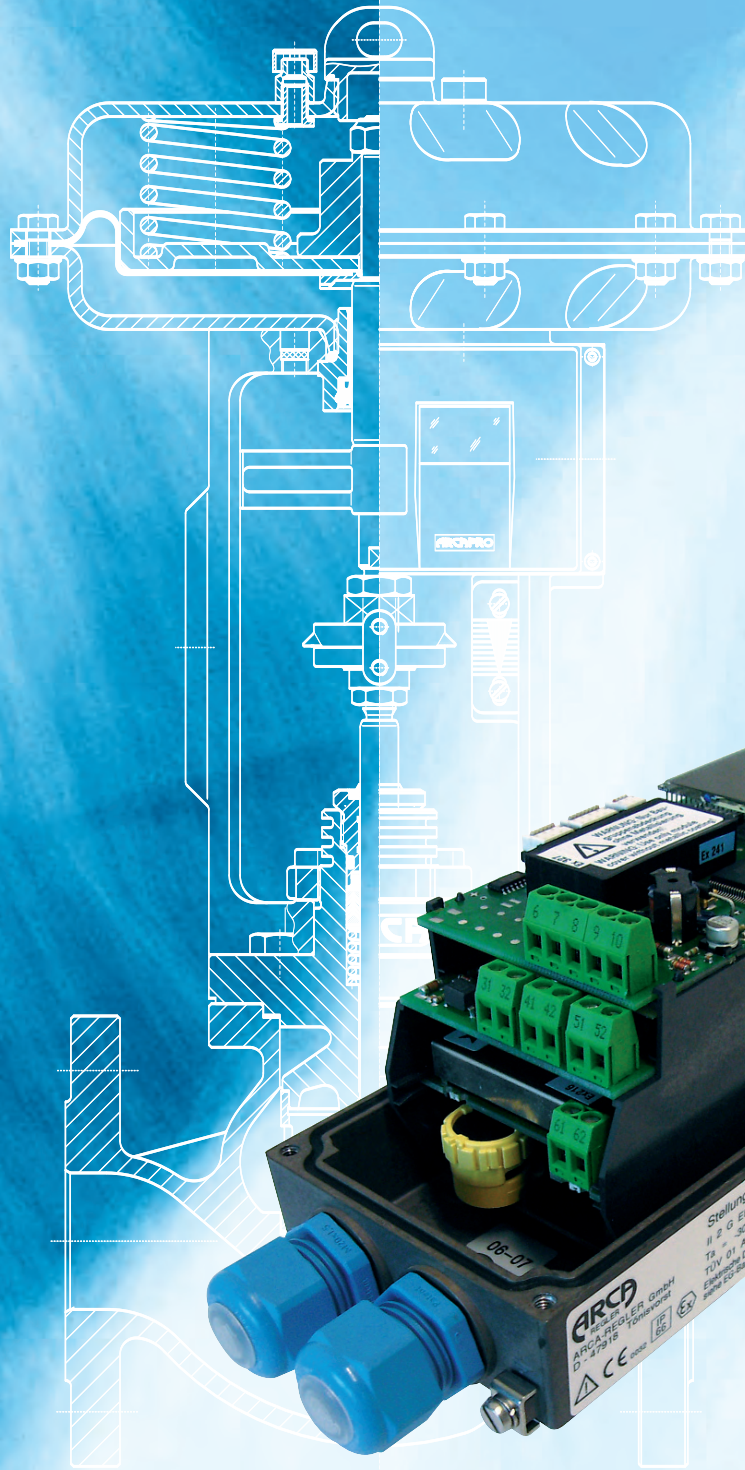

**ARCA**  
VALVES  
*quality engineered  
control valves*

## Positioner customized for specific tasks

A linear function between the input signal and stroke is the best way to ensure maximum control precision. Control valves with pneumatic actuators, however, are subject to friction, media pressure, and high flow forces, which means that this linearity is not intrinsic in the system. Only a positioner can eliminate positioning errors. To do so, it compares the input signal (reference variable  $w$ ) with the actual stroke (control variable  $x$ ). Depending on the control deviation ( $x_w$ ), the positioner uses the intake air pressure ( $p_z$ ) to yield the actuating pressure ( $p_s$ ) for the actuator (actuating variable  $y$ ). Either 0.2...1 bar, 4...20 mA or digital signals can be used as input signals.

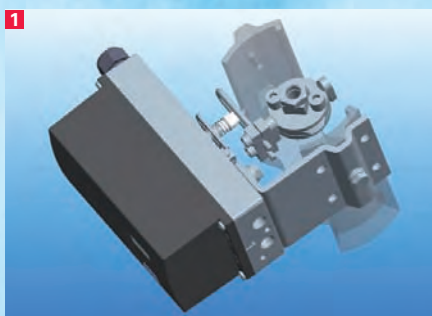
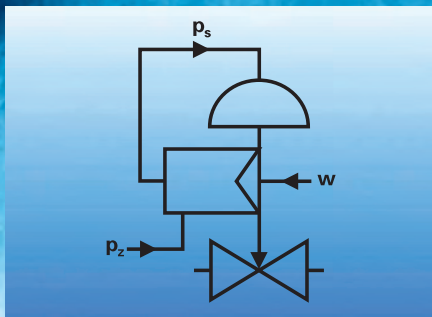

### 1 Positioner mounting to IEC 534 (NAMUR)

The standard mounting method to IEC 534 is based on manufacturer-neutral mechanical interfaces with the actuator yoke and stem. A bracket is normally used to secure the positioner, while the feedback lever comprises a lever with a spring element. The inlet air is connected to the positioner, while the pneumatic connection with the actuator is realized by means of a pipe or hose.

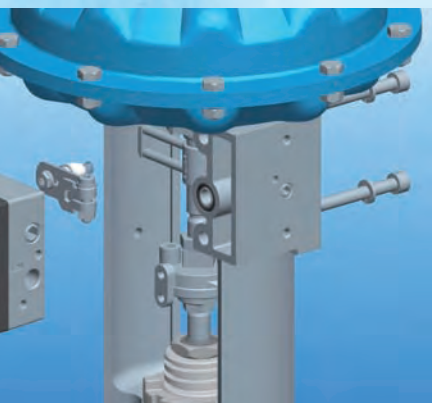

### 2 Direct integrated mounting

The positioner can be easily mounted on the actuator yoke by means of two screws to ensure that it is robust and protected against vibrations. The feedback lever is located within the yoke, which offers better protection than the NAMUR mounting method. The actuating pressure is channeled from the positioner through the actuator yoke to the actuator without the need for additional piping, thereby preventing any leakage. The inlet air is connected directly to the positioner.

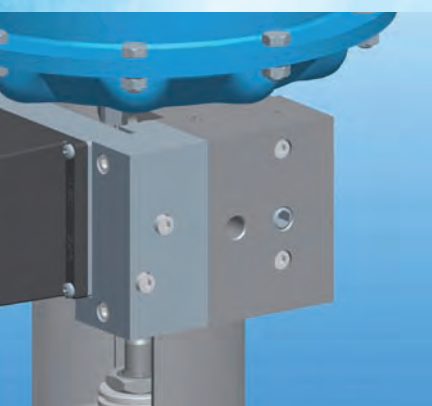

### 3 Integrated mounting to VDI/VDE 3847

As with the NAMUR mounting method, this method uses standardized mechanical interfaces with the actuator yoke and stem. The actuator interface, however, is also a pneumatic interface, which means that, as with the direct mounting method, the actuating pressure is channeled to the actuator through the actuator yoke. In addition, the rear of the yoke is equipped with an interface for a solenoid valve, which is pneumatically connected between the positioner and actuator, thereby enabling a safety shutdown of the unit. The inlet air is connected directly to the yoke, which means that no work needs to be carried out on the piping if the positioner is replaced.

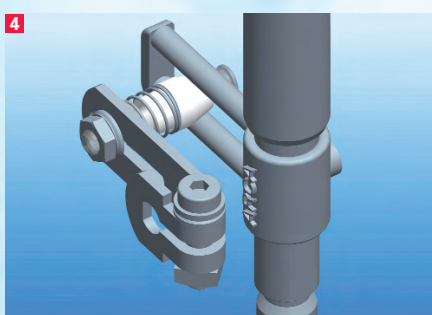

### 4 ARCAPLUG® position feedback

The patented ARCAPLUG® position feedback connects the valve stem and the stroke scanning lever. The tapered roller, which is made of wear-resistant plastic, grips between two pins on the stem. The spring mechanism for the tapered roller is self-adjusting, which means that the stroke is always detected without any zero backlash and without hysteresis. Even strong vibrations or heavy impacts do not cause any wear and tear, and the spacing tolerances of the pins are optimal equalized.



## The classic design: analog positioner type 824

### Functional principle

Positioner type 824 functions according to the tried-and-tested force-balance principle. The pneumatic setpoint standardized signal issued by a pneumatic controller or I/p converter module generates a force on the diaphragm that is balanced with the spring force on the feedback shaft. The resulting difference in force moves the gate valve, which connects the actuator with the intake air or atmosphere, thereby controlling the movement of the valve.

### Modular design

Pneumatic positioner type 824 is modular in design and can be expanded with a range of additional modules, thereby allowing it to be easily customized for specific tasks.

### I/p converter module

The I/p converter module converts electrical 0/4...20 mA input signals to pneumatic standardized signals with 0.2...1 bar for controlling the positioner.

### Limit switch module

Two adjustable inductive switches enable checkback signals for limit positions to be sent to the control system (e. g. as NAMUR signal).

### Feedback potentiometer

The feedback potentiometer generates a message containing the actual position for evaluation in the control system.

## The intelligent design: ARCAPRO® digital positioner type 827A

### Functional principle

ARCAPRO® is an intelligent, second-generation positioner. It not only offers a wider range of functions and higher level of reliability, but also features an advanced online diagnostics system and optional maintenance display. The position of the stem is sent to a potentiometer whose output signal is then compared with the setpoint by the microprocessor. Using a special control algorithm, the controller activates the two piezo valves, which connect the actuator with the inlet air or atmosphere.

The ARCAPRO® positioner can be operated locally or from the control room.

### Optimized operating modes

The ARCAPRO® positioner supports the following operating modes:

- Automatic or manual mode
- Initialization
- Parameterization
- Diagnostics

### Modular design

The ARCAPRO® positioner is compact and modular.

Additional modules increase your range of options:

- **Analog module:** Position transmitter for signaling the actual position as a current signal of 4...20 mA
- **Binary module:** Two adjustable software limit switches, fault signaling switch, binary input
- **Slot initiator module:** Two variable inductive limit switches, fault signaling switch
- **Contact module:** Two adjustable mechanical limit switches

### Automatic commissioning

The automatic initialization function allows you to commission the positioner quickly and easily. The parameters can be set on the device or by means of HART, PROFIBUS or Foundation Fieldbus communication. The following parameters can be set:

- Setpoint direction, characteristic
- Split-range mode
- Tight closing function
- Function for position and fault signaling outputs and the binary inputs

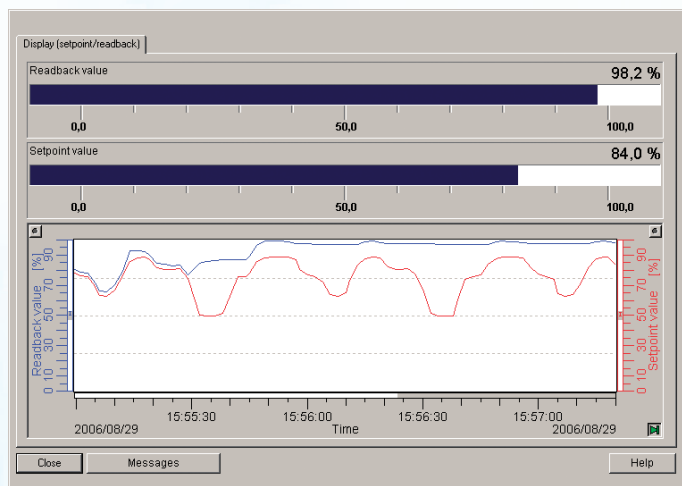

## Additional modules increase your range of options

### Position transmitter

The position transmitter comprises the feedback potentiometer and an R/I converter. It is used for signaling the actual position as a 0/4...20 mA signal.

### Gauge group

The gauge group displays the inlet air pressure, setpoint air pressure and actuating pressure. It also allows you to check whether or not the positioner is functioning properly.

### Explosion-protected designs

(for type 827A too)

- Intrinsically safe (EEx ia and EEx ia/ib)
- Explosion-proof (EEx d)
- Non-sparking (EEx n)

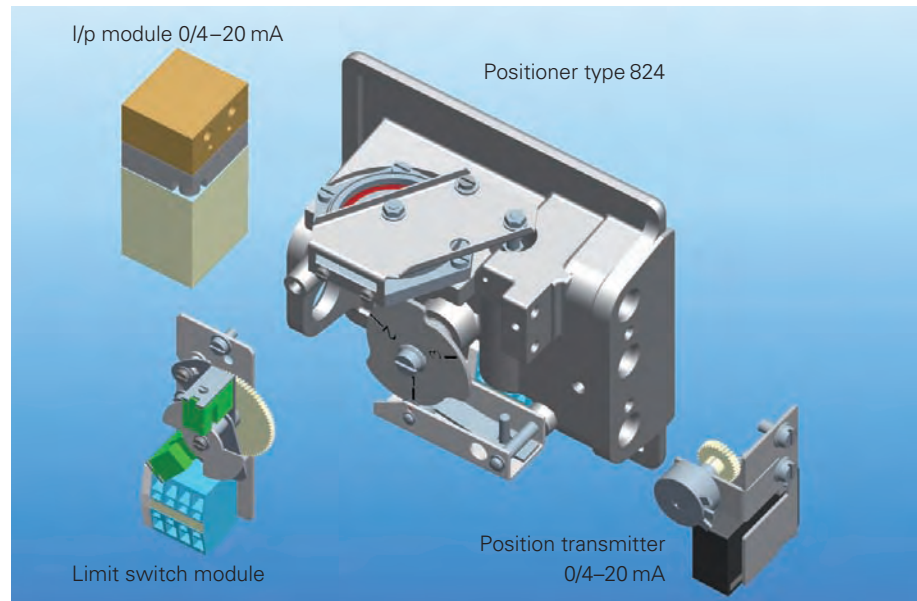

### Communication

Depending on the version, the ARCAPRO® positioner enables communication with other field devices or process control systems via:

- HART
- PROFIBUS PA
- Foundation Fieldbus

### Advanced online diagnostics to NE 91

The advanced online diagnostics function allows you to evaluate the status of the positioner. The diagnostics values can be displayed locally or queried via the communications cable. A range of additional functions that enable even more accurate status analyses are also available:

- Partial stroke test
- Leak measurement
- Limit temperature monitoring
- Mean position value calculation

### Maintenance data to NE 107

Three-stage limit value signaling to NE 107 can be carried out for the parameters acquired by means of the advanced online diagnostics function.

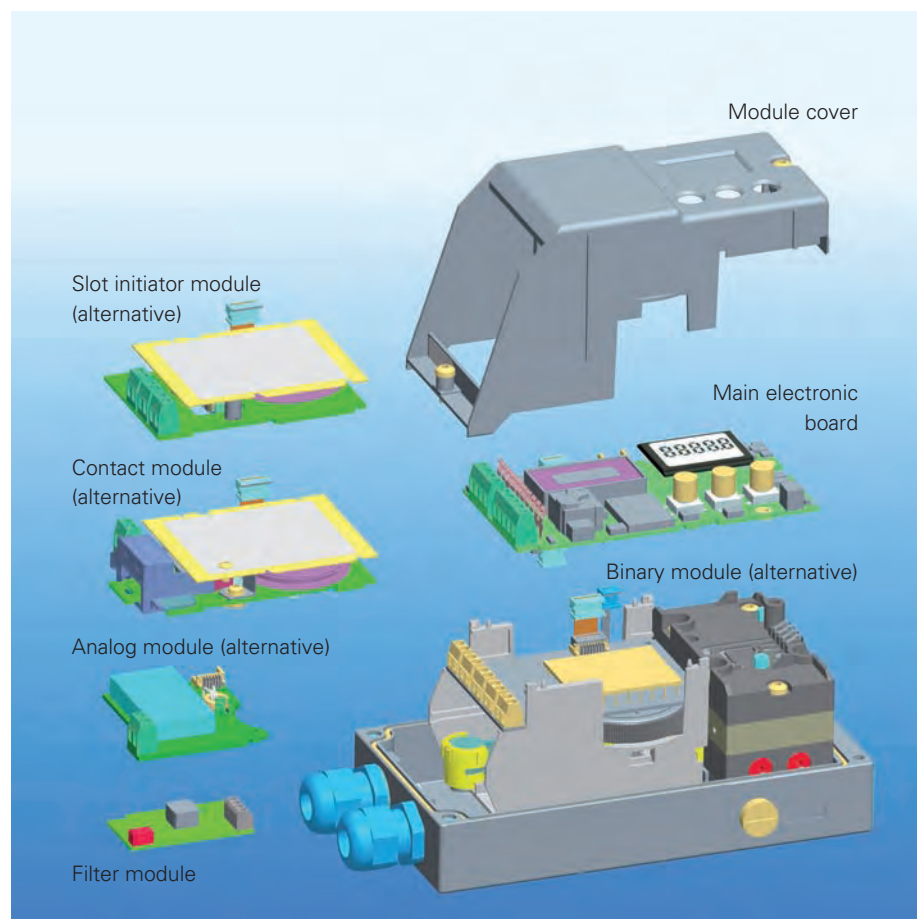

To enable this, the relevant limit values that trigger the signals must be defined for the following statuses:

- Medium-term need for maintenance
- Urgent need for maintenance
- Failure

The data is displayed on the device and can be sent to higher-level systems via the binary outputs or via HART or bus communication. The data is normally evaluated in the process control system.



## Analog and digital – precision through innovation

Since 1917 when it released its patented nozzle-flapper system, ARCA has been at the forefront of the industry for control valves with positioners. Our advances over the years have helped make modern positioner technology what it is today – and our state-of-the-art digital positioner ARCAPRO® is just the latest in a long line of innovations.

Thanks to automatic adjustment in line with the control valve and user-friendly parameterization (e. g. direction of action, split range or stroke limitation), the system is easy to commission and operate. In addition, a range of variable diagnostics parameters allow preventive maintenance measures to be specially planned to avoid plant downtime.

Modern communication options (e. g. HART, PROFIBUS, or Foundation Fieldbus) enable function and diagnosis parameters to be sent to process control systems for evaluation.

## ARCAPRO® positioner

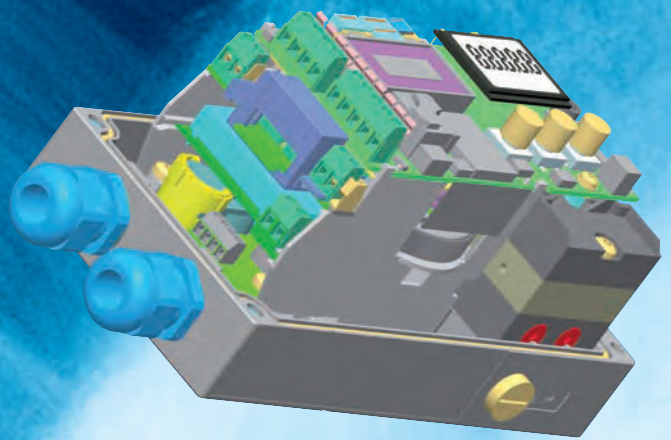

### Our innovation

- 1 Classic or intelligent digital positioners tried-and-tested over many years
- 2 Modular, retrofittable accessory and option modules
- 3 Integrated, pipe-free mounting
- 4 Patented ARCAPLUG feedback lever
- 5 Minimal air consumption
- 6 Universal communication
- 7 Advanced online diagnostics

### How you benefit

- ✓ Long service life
- ✓ Low lifecycle costs
- ✓ Optimal adaption to specific applications and control systems
- ✓ Compact design
- ✓ High mechanical resistance
- ✓ No sensitive piping
- ✓ Self-adjusting
- ✓ No hysteresis
- ✓ Minimal wear and tear
- ✓ Low operating costs
- ✓ Easy adjustment in line with existing plant communication systems
- ✓ All diagnostics data can be read on the device or in the control room
- ✓ Self-monitoring of the complete valve
- ✓ Precise planning of maintenance measures

# ARCAPRO® positioner

## Positioner type 824

<b>General data</b>	Enclosure material	Anodized aluminum / Glass-fiber-reinforced polyester
	Temperature range	-40...+80 °C
	Steady-state deviation	< 0,5 %
	Linearity error	< 2 %
	Hysteresis	< 0,7 %
<b>Explosion protection</b>	without / intrinsically safe / explosion-proof	
<b>Input signal</b>	0,2...1 bar or 0/4...20 mA 2 wire connection	
<b>Option modules</b>	Position transmitter	4...20 mA, passive, 2/3 wire connection (not explosion proof)
	Limit switch	2 NAMUR sensors
<b>Pneumatic data</b>	Inlet air pressure	1.4...6 bar
	Continuous air consumption	< 500 Ndm³/h
<b>Mounting</b>	Linear actuators	ARCA-integrated or to IEC 534; range of stroke 10...120 mm
	Quarter turn actuators	To VDI/VDE 3845; angle of rotation 90°

## ARCAPRO® positioner type 827A

<b>General data</b>	Enclosure material	Anodized aluminum, stainless steel, polycarbonate
	Temperature range	-30...+80 °C
	Steady-state deviation	Typically < 0,3 %
	Linearity error	Typically < 0,5 %
	Dead zone	Self-adjusting (typically 0.3 %) or adjustable (0.1 % to 10 %)
<b>Explosion protection</b>	without / intrinsically safe / non-sparking / explosion-proof	
<b>Communication / input signal</b>	Standard / HART	4...20 mA 2 wire connection, 0/4...20 mA 3/4 wire connection
	Profibus PA	Profibus PA, profile B, version 3.0
	Foundation Fieldbus	H1 communication
<b>Binary inputs</b>	Switching or voltage inputs, parameterizable (e. g. «Move valve to CLOSED»)	
<b>Option modules</b>	Analog module	4...20 mA position transmitter, passive
	Binary module	2 NAMUR limit switches, 1 NAMUR fault switch, 1 binary input
	Slot initiator module	2 inductive NAMUR limit switches, 1 NAMUR fault switch
	Contact module	2 mechanical limit switches
<b>Pneumatic data</b>	Inlet air pressure	1.4...7 bar
	Continuous air consumption	< 36 Ndm³/h
<b>Mounting</b>	Linear actuators	ARCA-integrated, integrated to VDI/VDE 3847 or to IEC 534; range of stroke 3...130 mm
	Quarter turn actuators	Integrated to VDI/VDE 3847 or VDI/VDE 3845; angle of rotation 30...100°

### ARCA Regler GmbH

Kempener Strasse 18, Postfach 2120, D-47913 Tönisvorst  
 Phone +49 (0)2156-7709-0, Fax +49 (0)2156 7709-55  
[www.arca-valve.com](http://www.arca-valve.com), [sale@arca-valve.com](mailto:sale@arca-valve.com)

ARCA Flow Group worldwide: Competence in valves, pumps & cryogenics

