

eliwell

DR4000
DR4020-4022



EN

Temperature controllers and process controllers.

DR4000

Temperature controllers and process controllers.

Universal Controller

Process value(PV):

Used to display the process value, and the labels of parameters, alarms and functions.









Set value (SV):

Used to display the setpoint, parameter values, function statuses and other statuses.







NOTE: If "Upper" **PV** DISPLAY is FLASHING the value of "Lower" **SV** DISPLAY is editable.

KEYS & LEDs



	<p>UP press and release Scrolls through menu items Increases values on the display Hold down for at least 5 sec User-configurable function (parameter H31)</p>		<p>°C LED Steadily lit: °C setting (dro =0) Off: when output not active</p>
	<p>DOWN Press and release Scroll through menu options Decreases values Hold down for at least 5 sec User-configurable function (parameter H32)</p>		<p>°F LED Steadily lit: °F setting (dro =1) Off: when output not active</p>
	<p>set Press and release Display alarms (if present) Open Machine Status menu Hold down for at least 5 sec Open Programming menu Confirm commands</p>		<p>Alarms LED Steadily lit: alarm present Blinking: alarm acknowledged OFF: when output not active</p>
	<p>fnc Press and release Open Functions menu ESC (exit) function</p>	<p>Tun.</p>	<p>NOT USED</p>
	<p>aux press and release User configurable function (parameter H34)</p>	<p>S.Str</p>	<p>S.Str Steadily lit: Soft Start function enabled OFF: when output not active</p>
		<p>out1</p>	<p>out 1 Steadily lit: output active Blinking: delay, protection or start-up blocked OFF: when output not active</p>
		<p>aux</p>	<p>aux Steadily lit: output active OFF: when output not active</p>
		<p>out2</p>	<p>out 2 Steadily lit: output active Blinking: delay, protection or start-up blocked OFF: when output not active</p>

"MACHINE STATUS" MENU









The following procedure is to be followed in order to set the 2 setpoint values in the device, SEt1 and SEt2.

			
<p>1) Press and release the 'set' key on the first window of the display (probe Pb1 value).</p>	<p>2) Label SEt1 is shown on the PV display, while the current value of the Setpoint is shown on the SV display. Press the 'set' key again, the PV display will blink and you can edit the value on the SV display.</p>	<p>3) Use the UP and DOWN keys to change the setpoint value shown on the SV display.</p>	<p>4) When the 'set' or "fnc" key is pressed, or after timeout (15 sec), the new value appears and the initial screen is restored on the display.</p>

PASSWORDS

Password "**PA1**": access to "**User Menu**" parameters. The password is disabled by default (**PS1=0**). To enable it (**PS1≠0**): hold down the  key for at least 5 seconds and then scroll through the parameters with  and  until finding label **PS1**.

To change the value, press the  key. The parameter label will start to blink. Change the value (shown on the second line) using the  and  keys, then press the  or  keys to store the new value.

Password "**PA2**": access to "**Installer Menu**" parameters. By default the password is disabled (**PS2=0**). To enable it (**PS2≠0**): hold down the  key for at least 5 seconds and scroll through the "User Menu" parameters with  and  until finding label **PA2**. Press  and scroll through the parameters with  and  until reaching folder **diSP** then press . Scroll through the parameters using  and  until you find the label **PS2**.

To change the value, press the  key. The parameter label will start to blink. Change the value (shown on the second line) using the  and  keys, then press the  or  keys to store the new value.







The visibility of "**PA2**" is as follows:

- 1) if **PA1** and **PA2≠0**: Press and hold down for longer than 5 seconds to display "**PA1**" and "**PA2**". You can then decide whether to access the "**User Menu**" parameters (PA1) or the "**Installer Menu**" parameters (PA2).
- 2) **Otherwise**: Password "PA2" is amongst the level1 parameters. If enabled, it will be required when accessing the "Installer Menu" parameters; to enter it, proceed as instructed for password "PA1"

If the entered value is incorrect, the label PA1/PA2 will be displayed once again and the procedure must be repeated.

UNICARD / COPY CARD

The Unicard/Copy Card is an accessory connected to the TTL serial port used for quick programming of the device parameters (upload and download a parameter map to one or more devices of the same type). The upload (label UL), download (label dL) and Unicard/copy card formatting (label Fr) operations are performed as explained below:

<p>① </p>	<p>② </p>	<p>③ </p>
<p>The controls necessary for using the Unicard/Copy Card are present inside the 'FPr' folder contained level 1 of the programming menu. Press "set" to access the functions.</p>	<p>Press  and  to scroll through the functions until the desired function is displayed. Press the  key and the selected function (upload, download or formatting) will be executed.</p>	<p>If the operation is successful, the display will show y, otherwise it will show n.</p>

Download from reset: Connect the Unicard/Copy Card with the device OFF.

The programming parameters are uploaded when the instrument is switched on; once the lamp test is concluded, the display shows the following for about 5 seconds:

- label **dLY** if copy operation is successful
- label **dLn** if operation fails

NOTES:

- after the parameters have been uploaded from reset, the instrument will use the newly uploaded map settings.
- **see FPr** folder in 'Parameters' on pages 4-5

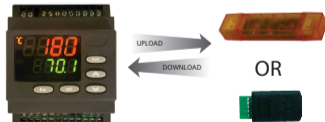

"FUNCTIONS" MENU

The Functions Menu contains a number of special functions that can be used to configure and manage the device: the Functions Folder and the Alarms Folder (if at least one alarm is present).



After pressing the **fnC** key, you can scroll through the two folders in the menu (FnC and ALAr) using the **⏪** and **⏩** keys.

The following is a description of the menu structure and the functions in the individual files. Press the 'set' key next to label FnC to access the functions.



The label will be displayed, with the current status of the function. To browse all functions, use the **⏪** and **⏩** keys.

To change the status of a given function, press the **set** key.

Function	Label	Default state	D.I. (H11)	Key (H3...H34)	Active signalling function
Soft Start	S.Str	ON	1	1	S.Str LED ON
Standby	Stnb	OFF	5	5	/

"USER" Menu

To access the "USER Menu", hold down the **set** key for more than 5 seconds. If enabled, the "PA1" access PASSWORD will be requested (see "PASSWORD" section). Press the **set** key to edit the parameter values. The display will show the first parameter in the menu (e.g. parameter "dF1"). Use the **⏪** and **⏩** keys to scroll through all the parameters in the menu:

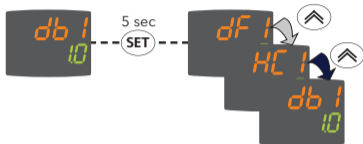

Select the desired parameter using the **⏪** and **⏩** keys.

To change the value, press the **set** key. The parameter label will start to blink. Change the value (shown on the second line) using the **⏪** and **⏩** keys, then press the **set** or **fnC** keys to store the new value.



NOTE: It is advisable to switch the instrument off then back on again each time parameters are modified to prevent malfunction of the configuration and/or timer operations underway.

"USER" Menu PARAMETERS table

Parameter	DESCRIPTION	RANGE	UM	DR4020	DR4022
dF1	Relay 1 activation differential	0.1 ... 30.0	°C/°F	1.0	1.0
HC1	Control mode selection. H = Hot; C = Cold	H/C	flag	H	H
db1	Response band above SEtpoint SEt1	0.0 ... 30.0	°C/°F	1.0	1.0
dF2	Relay 2 activation differential	0.1 ... 30.0	°C/°F	1.0	1.0
HC2	Control mode selection. H = Hot; C = Cold	H/C	flag	H	H
db2	Response band above SEtpoint SEt2	0.0 ... 30.0	°C/°F	1.0	1.0
HS1	Maximum value assignable to SEtpoint SEt1	LSE ... 302	°C/°F	See table "Installer" parameters	
LS1	Maximum value assignable to SEtpoint SEt1	-58.0 ... HSE	°C/°F		
HS2	Maximum value assignable to SEtpoint SEt2	LSE ... 302	°C/°F		
LS2	Maximum value assignable to SEtpoint SEt2	-58.0 ... HSE	°C/°F		
HA1	OUT1 Maximum temperature alarm	See "Installer" parameters table			
LA1	OUT1 Minimum temperature alarm				
HA2	OUT2 Maximum temperature alarm				
LA2	OUT2 Minimum temperature alarm				
CAi	Type of calibration action	0/1/2	num	2	2
H00	Selection of probe type	See "Installer" parameters table			
H01	Configuration of controllers OUT1 and OUT2 .	0 ... 6	num	4	4
H03	Lower limit of current/voltage input (V/I models only)	-1999 ... 9999	num	0	0
H04	Upper limit of current/voltage input (V/I models only)	-1999 ... 9999	num	100	100
ndt	Display with/without decimal point	See "Installer" parameters table			
dro	Select probe display type				
LOC	Keypad lock. " y " = keypad locked; " n " = keypad unlocked	n/y	flag	n	n
PS1	Password to level 1 parameters (USER)	0 ... 999	num	0	0
rEL	Firmware release. Device version. Reserved: read-only parameter.	/	/	/	/
tAb	Parameters tAble. Reserved: read-only parameter.	/	/	/	/
PA2	Access to level 2 parameters (INSTALLER). See Password and Programming Menu sections.				

"INSTALLER" Menu

To access the "INSTALLER Menu", hold down the **set** key for more than 5 seconds. Using the **⏶** and **⏷** keys, display parameter "PA2" and select it by pressing the **set** key. If enabled, enter the "PA2" access PASSWORD (see "PASSWORD" section).

The display will show the first folder in the ADVANCED menu (e.g. folder "rE1"). By pressing the **⏶** and **⏷** keys you can scroll through all the folders in the "INSTALLER" menu:



Press the **set** key next to the desired folder ("rE2" in the example), the first parameter contained in the folder will be displayed. Select the desired parameter using the **⏶** and **⏷** keys. Change the value (shown on the second line) using the **⏶** and **⏷** keys, then press the **set** or **func** keys to store the new value.



- NOTE:**
- 1) It is advisable to switch the instrument off then back on again each time parameters are modified to prevent malfunction of the configuration and/or timer operations underway.
 - 2) The "INSTALLER Menu" contains all the device parameters, including those contained in the "USER Menu".

"INSTALLER" Menu PARAMETERS table

PAR.	DESCRIPTION	U.M.	RANGE	MODEL	DR4020	DR4022
SEt1	Temperature control SEtpoint 1.	°C/°F	LS1 ... HS1	ALL	0.0	0.0
SEt2	Temperature control SEtpoint 2.	°C/°F	LS2 ... HS2	ALL	0.0	0.0
CONTROLLER 1 (Folder rE1)						
OS1	Setpoint 1 Offset. Temperature value to be added algebraically to the setpoint if reduced set enabled (Economy function). It cannot assume the value 0.	°C/°F	-30.0...30.0	ALL	0.0	0.0
db1	Response band above SEtpoint SEt1 .	°C/°F	0.0 ... 30.0	ALL	1.0	1.0
dF1	Relay 1 activation differential. The service will stop when SEt1 is reached (value read by Pb1) and restart at the (SEt1+DiF value.	°C/°F	0.1 ... 30.0	ALL	1.0	1.0
HC1	Control mode selection. "H" = Hot, "C" = Cold	flag	C/H	ALL	H	H
HS1	Maximum value assignable to SEtpoint "SEt1"	°C/°F	LS1 ... HdL	TcJ/TcK	760.0	760.0
				PTC/NTC/PT1000	800.0	800.0
				PT100	800.0	800.0
				V/I	100.0	100.0
LS1	Minimum value assignable to SEtpoint "SEt1"	°C/°F	LdL... HS1	TcJ/TcK	-40.0	-40.0
				PTC/NTC/PT1000	-200	-200
				PT100	-200	-200
				V/I	0.0	0.0
HA1	OUT 1 Maximum temperature alarm (see 'MAX/MIN Temperature Alarms' diagram)	°C/°F	LA1 ... 2910	TcJ/TcK	2910	2910
				PTC/NTC/PT1000	2910	2910
			LA1 ... 999,9	PT100	2910	2910
				V/I	100.0	100.0
LA1	OUT 1 Minimum temperature alarm (see 'MAX/MIN Temperature Alarms' diagram)	°C/°F	-328 ... HA1	TcJ/TcK	-40.0	-40.0
				PTC/NTC/PT1000	-328	-328
				PT100	-328	-328
			-199.9 ... HA1	V/I	0.0	0.0

PAR.	DESCRIPTION	U.M.	RANGE	MODEL	DR4020	DR4022
dn1	Start delay. The indicated time must elapse between the request for activation of the controller relay and switch-on.	sec	0 ... 255	ALL	0	0
do1	Delay time after switch-off. The indicated time must elapse between deactivation of the controller 1 relay and the next switch-on.	min	0 ... 255	ALL	0	0
di1	Time lag between starts. The indicated time must elapse between two consecutive starts of controller 1.	min	0 ... 255	ALL	0	0
dE1	Switch-off delay. The indicated time must elapse between the request for deactivation of the controller 1 relay and switch-off. NOTE: for parameters dn1, do1, di1, dE1, value 0 = not active	sec	0 ... 255	ALL	0	0
On1	Controller switch-on time in the event of faulty probe. If On1 = "1" and OF1 = "0" the controller remains on continuously; if On1 = "1" and OF1 > "0" it operates in Duty Cycle mode. (see the Duty Cycle diagram)	min	0 ... 255	ALL	0	0
OF1	Controller switch-off time in the event of a faulty probe. If OF1 = "1" and On1 = "0" the controller remains off continuously; if OF1 = "1" and On1 > "0" it operates in Duty Cycle mode. (see the Duty Cycle diagram)	min	0 ... 255	ALL	1	1
CONTROLLER 2 (Folder rE2)						
OS2	Setpoint 2 Offset. Temperature value to be added algebraically to the setpoint if reduced set enabled (Economy function). It cannot assume the value 0.	°C/°F	-30.0 ... 30.0	ALL	0.0	0.0
db2	Response band above SEtpoint SEt2 .	°C/°F	0.0 ... 30.0	ALL	1.0	1.0
dF2	Relay 1 activation differential. The service will stop when SEt2 is reached (value read by Pb1) and restart at the (SEt2+DiF) value.	°C/°F	0.1 ... 30.0	ALL	1.0	1.0
HC2	Control mode selection. "H" = Hot, "C" = Cold	flag	C/H	ALL	H	H
HS2	Maximum value assignable to SEtpoint "SEt2"	°C/°F	LS2 ... HdL	TcJ/TcK	760.0	760.0
				PTC/NTC/PT1000	800.0	800.0
				PT100	800.0	800.0
				V/I	100.0	100.0

PAR.	DESCRIPTION	U.M.	RANGE	MODEL	DR4020	DR4022
LS2	Minimum value assignable to SETpoint "Set2"	°C/°F	LdL... HS2	TcJ/TcK	-40.0	-40.0
				PTC/NTC/PT1000	-200	-200
				PT100	-200	-200
				V/I	0.0	0.0
HA2	OUT 2 Maximum temperature alarm (see 'MAX/MIN Temperature Alarms' diagram)	°C/°F	LA2 ... 2910	TcJ/TcK	2910	2910
				PTC/NTC/PT1000	2910	2910
			LA2 ... 999.9	PT100	2910	2910
				V/I	999.9	999.9
LA2	OUT 2 minimum temperature alarm (see 'MAX/MIN Temperature Alarms' diagram)	°C/°F	-328 ... HA2	TcJ/TcK	-40.0	-40.0
				PTC/NTC/PT1000	-328	-328
			-199.9 ... HA2	PT100	-328	-328
				V/I	0.0	0.0
dn2	Start delay. The indicated time must elapse between the request for activation of the controller relay and switch-on.	sec	0 ... 255	ALL	0	0
do2	Delay time after switch-off. The indicated time must elapse between deactivation of the controller 2 relay and the next switch-on.	min	0 ... 255	ALL	0	0
di2	Time lag between starts. The indicated time must elapse between two consecutive switch-ons of controller 2.	min	0 ... 255	ALL	0	0
dE2	Switch-off delay. The indicated time must elapse between the request for deactivation of the controller 2 relay and switch-off. NOTE: for parameters dn2, do2, di2, dE2 value 0 = not active	sec	0 ... 255	ALL	0	0
On2	Controller switch-on time in the event of faulty probe. If On2 = "1" and OF2 = "0" the controller remains on continuously; if On2 = "1" and OF2 > "0" it operates in Duty Cycle mode. (See the Duty Cycle diagram)	min	0 ... 255	ALL	0	0
OF2	Controller switch-off time in the event of a faulty probe. If OF2 = "1" and On2 = "0" the controller remains off continuously; if OF2 = "1" and On2 > "0" it operates in Duty Cycle mode. (See the Duty Cycle diagram)	min	0 ... 255	ALL	1	1

PAR.	DESCRIPTION	U.M.	RANGE	MODEL	DR4020	DR4022
ANALOGUE OUTPUT (Folder AnOu)						
AOL	Analogue output operating mode: 020 = 0...20mA; 420 = 4...20mA; 001 = 0...1V; 005 = 0...5V; 010 = 0...10V.	num	020/420/001 005/010	ALL		020
AOF	Analogue output operating mode: dis = output disabled; ro = read out. Output proportional to probe reading, within the range set by parameters LAO and HAO; Er = error, output proportional to the error between Setpoint1 and the value read by the probe, within the error values specified by parameters LAO and HAO. cPH = not used cPc = not used	num	dis ro Er cPH cPc	ALL		ro
AOS	Analog output operating mode if probe faulty: Aon = analog output ON; AoF = analog output OFF	flag	Aon/AoF	ALL		AoF
LAO	Analog output minimum limit	num	LdL... HdL	ALL		0.0
HAO	Analog output maximum limit	num	LdL... HdL	ALL		100.0
SOFT START CONTROLLER (Folder Sft)						
dSi	Dynamic step increment (Step Value). Value (in degrees) of each subsequent increase (dynamic) of the setpoint. (0 = SOFT START function disabled).	°C/°F	0.0 ... 25.0	ALL	0.0	0.0
Std	duration of step for SOft Start controller (unit of measurement defined by Unt)	min	0 ... 255	ALL	0	0
Unt	Unit of measurement (0 = hours, 1 = minutes, 2 = seconds)	num	0/1/2	ALL	1	1
SEn	Outputs enabled function sensitivity. Establishes which outputs the function must be enabled on: 0 = disabled; 1 = enabled OUT1; 2 = enabled OUT2; 3 = Enabled OUT 1 & 2;	num	0/1/2/3	ALL	1	1
Sdi	Function reactivation threshold. Establishes the threshold beyond which the SOFT START function is automatically reactivated	°C/°F	0.0 ... 30.0	ALL	0.0	0.0

PAR.	DESCRIPTION	U.M.	RANGE	MODEL	DR4020	DR4022
CYCLIC CONTROLLER (Folder cLc)						
Con	ON time for cyclic controller output	min	0 ... 255	ALL	0	0
CoF	OFF time for cyclic controller output	min	0 ... 255	ALL	0	0
ALARMS (Folder ALAr)						
Att	Parameter HA1/2 and LA1/2 modes, as absolute temperature values or as differential compared with the Setpoint. (Abs = absolute value; reL = relative value).	flag	Abs/reL	ALL	Abs	Abs
AFd	Alarm activation differential. It works with parameters "HA1/2" and "LA1/2". (see 'MAX/MIN Temperature Alarms' diagram)	°C/°F	1.0 ... 50.0	ALL	2.0	2.0
PAO (!)	Power-on Alarm Override. Alarm exclusion time (expressed in hours) after instrument is switched on following a power failure.	hours	0 ... 10	ALL	0	0
SAO	Alarm exclusion time until the Setpoint is reached. If "SAO" = 0 it is disabled. - If "SAO">0, an alarm will be generated if the Setpoint is not reached after the time (in hours) set by this parameter.	hours	0 ... 24	ALL	0	0
tAO	Temperature Alarm Override. Temperature alarm signal delay time.	min	0 ... 255	ALL	0	0
AOP	Alarm output polarity. nC = normally closed; nO = normally open;	flag	nC/nO	ALL	nC	nC
COMMUNICATION (Folder Add)						
PTS	Select communication protocol (t = Televis; d = Modbus)	flag	t/d	ALL		0
dEA	device address within the family (valid values from 0 to 14).	num	0 ... 14	ALL		0
FAA	device family (valid values from 0 to 14). The pair of values FAA and dEA are the network address of the device and are given in the format "FF.DD" (where FF= FAA and DD= dEA).	num	0 ... 14	ALL		0
Pty	Modbus parity bit: n = none; E = Even; o = odd;	flag	n/E/o	ALL		1
StP	Modbus stop bit: 1b =1 bit; 2b =2 bit;	flag	1b/2b	ALL		0

PAR.	DESCRIPTION	U.M.	RANGE	MODEL	DR4020	DR4022
DISPLAY (Folder diSP)						
LOC	Keypad lock and Setpoint modification. It is still possible to access parameter programming and edit parameters, including LOCK status. (y = Keypad LOCKED; n = Keypad UNLOCKED).	flag	n/y	ALL	n	n
PS1	Password 1. When enabled (PS1 ≠ 0), this password provides access to level 1 parameters (USER).	num	0 ... 999	ALL	0	0
PS2	Password 2. When enabled (PS2 ≠ 0), this password provides access to level 2 parameters (INSTALLER).	num	0 ... 999	ALL	0	0
ndt	Display with/without decimal point. TcJ/TcK/PTC/NTC/PT1000/PT100 models: y = with decimal point; n = without decimal point; Ent = not used. V/I models: (number of digits after the point) 0 = whole number; 1 = one digit; 2 = two digits; 3 = three digits.	num	n/y/Ent 0/1/2/3	TcJ/TcK		
				PTC/NTC/PT1000	y	y
				PT100	y	y
				V/I	1	1
				I	1	1
CA1	Probe 1 calibration. Positive or negative temperature value added to the value read by probe 1, before it is displayed and used for control, according to the setting of parameter "CAi".	°C/°F	-30.0 ... 30.0	ALL	0.0	0.0
CAi	Calibration operation: - 0 = sum with displayed temperature only; - 1 = sum with only the temperature used by the controllers and not for the display, which remains unchanged; - 2 = sum with the displayed temperature, which is also used by the controllers;	num	0/1/2	ALL	2	2
LdL	Low display Level. Minimum value that can be displayed by the device.	°C/°F	-328 ... HdL -199.9 ... HdL	TcJ/TcK	-40.0	-40.0
				PTC/NTC/PT1000	-328	-328
				PT100	-328	-328
				V/I	0.0	0.0
HdL	High display Level. Maximum value that can be displayed by the device.	°C/°F	LdL ... 2910 LdL ... 999.9	TcJ/TcK	2910	2910
				PTC/NTC/PT1000	2910	2910
				PT100	2910	2910
				V/I	100.0	100.0

PAR.	DESCRIPTION	U.M.	RANGE	MODEL	DR4020	DR4022			
dro	Select probe display type. TcJ/TcK/PTC/NTC/PT1000/PT100 models: C = °C, F = °F. V/I models: C = °C, F = °F, bAr = Bar; rH = %RH, PA = Pascal, PSi = PSi, null = empty	flag	C/F	TcJ/TcK	C	C			
				PTC/NTC/PT1000	C	C			
				PT100	C	C			
			C/F/bAr/rH/ PA/PSi/null	V	C	C			
				I	C	C			
ddd	View basic status of the display. 0 = Setpoint 1; 1 = Setpoint 2; 2 = % analog output	flag	0/1/2	ALL	0	0			
CONFIGURATION (Folder CnF)									
H00	Probe type selection. Tc: tcj = TcJ; tcH = TcK. PTC/NTC/PT1000: ntC = NTC; Ptc = PTC; Pt10 = PT1000, Pt1 = not used. V: 020, 420 e t01 = not used; t05 = 0...5V, t10 = 0...10V. I: 020 = 0...20mA, 420 = 4...20mA, t01 = 0...1V; t05 e t10 = not used.	flag	tcj/tcH	TcJ/TcK	tcj	tcj			
			ntC/Ptc/Pt10	PTC/NTC/PT1000	ntC	ntC			
			Pt1	PT100					
			t05/t10	V	t05	t05			
			020/420/t01	I	420	420			
H01	Configuration of controllers.				num	0 ... 6	ALL	4	4
	H01	Description	OUT 1	OUT 2					
	0	free	H21	H22					
	1	ON/OFF	H/C	H22					
	2 and 3	not used	-	-					
	4	2 independent ON/OFFs	H/C	H/C					
	5	2 dependent ON/OFFs	H/C	H/C					
6	neutral zone	H/C	H/C						
H02	Key activation time, when configured with a second function. Press the ESC, UP and DOWN keys (if configured for a second function) for the time "H02" to activate the function itself. NOTE: The AUX function has a fixed activation time of 0.5 seconds.	sec	0 ... 15	ALL	5	5			

PAR.	DESCRIPTION	U.M.	RANGE	MODEL	DR4020	DR4022
H03	Lower input current/voltage limit:	num	---	T _c /T _c K		
				PTC/NTC/PT1000		
				PT100		
			-1999...9999	V/I	0	0
H04	Higher input current/voltage limit:	num	---	T _c /T _c K		
				PTC/NTC/PT1000		
				PT100		
			-1999... 999	V/I	100	100
H06	Key or aux/light digital input active with device OFF; n= not active; y= active.	flag	n/y	ALL	y	y
H08	Standby mode: 0 = only display switches off; 1 = display on and controllers locked; 2 = display off and controllers locked	num	0/1/2	ALL	2	2
H10	Delay for output activation after Power On; minimum delay time for connection of loads in the event of restart after a power failure.	num	0 ... 255	ALL	0	0
H11	Digital Input Configuration (D.I.) 0 = disabled; 1 = SOFT START; 2 = Setpoint Offset; 3 = Cyclic controller; 4 = AUX; 5 = stand-by (ON-OFF); 6-7-8 = not used; 9 = external alarm; 10 = external alarm with controllers trip; 11 = hot/cold mode.	num	0 ... 11	ALL		0
H13	Digital Input polarity and priority. no =normally open; nc =normally closed; noP =normally open with priority; ncP =normally closed with priority	num	no/nc/noP/ ncP	ALL		no
H14	Digital input activation delay.	num	0 ... 255	ALL		0
H21	Configurability of digital output 1: 0=disabled; 1=alarm; 2=cyclic; 3=aux/light; 4=standby;	num	0 ... 4	ALL	0	0
H22	Configurability of digital output 2 (if present): Same as H21	num	0 ... 4	ALL	0	0

PAR.	DESCRIPTION	U.M.	RANGE	MODEL	DR4020	DR4022
H25	Enable buzzer (only if buzzer is present). n = not enabled; y = enabled	flag	n/y	ALL	n	n
H31 (!)	UP key configuration. 0 = disabled; 1 = SOFT START; 2 = Setpoint Offset; 3 = Cyclic Controller; 4 = AUX; 5 = STAND-BY; 6-7-8 = Not used; 9 = hot/cold mode.	num	0 ... 9	ALL	0	0
H32	DOWN key configuration. Same as "H31".	num	0 ... 9	ALL	0	0
H34	AUX key configuration. Same as "H31".	num	0 ... 9	ALL	0	0
reL	Firmware release. Device version. Reserved: read-only parameter.	/	/	ALL	/	/
tAb	tAble of parameters. Reserved: read-only parameter	/	/	ALL	/	/
PA2**	Access to level 2 parameters (INSTALLER). See Password and Programming Menu sections.					
UNICARD / COPY CARD (folder FPp)						
UL	UpLoad. Transfer of programming parameters from instrument to Unicard/ Copy Card	/	/	ALL	/	/
dL	downLoad. Transfer of programming parameters from Unicard/Copy Card to instrument	/	/	ALL	/	/
Fr	Format. Cancels all data entered in the Unicard/Copy Card. IMPORTANT: If parameter "Fr" (Unicard/Copy Card formatting) is used, the data entered in the card will be permanently lost. This operation cannot be reversed. The controller must be switched off and then on again after the operation with the Unicard/Copy Card.	/	/	ALL	/	/
<p>NOTES: 1) PA2** is visible (if enabled) at Level1 in folder CnF and can be set at Level2 in folder "dISP" with parameter PS2.</p> <p>2) If the value box is blank or coloured black this means that the parameter is not available in this model</p> <p>3) If one or more parameters marked with (!) are edited, the controller MUST be switched off after the modification and then switched back on.</p> <p>4) It is strongly recommended that you switch the device off and on again each time the parameter configuration is changed, in order to prevent malfunctioning of the configuration and/or ongoing timings.</p>						

TECHNICAL SPECIFICATIONS (EN 60730-2-9)

Use:	operating (not safety) device for incorporation
Mounting:	on DIN rail (Omega 3) or panel mounting, with 70x45mm opening.
Type of action:	1.B
Pollution class:	2
Material class:	IIIa
Overvoltage category:	II
Nominal pulse voltage:	2500V
Temperature:	Use: -5.0 ... +55.0°C - Storage: -20.0 ... +85.0°C
Power supply:	Switching: 100 ... 240V~ (+10% / -10%) 50/60 Hz Switching: 12 ... 24V~ or 12 ... 36V= (+10% / -10%) 50/60 Hz
Power consumption:	4W max
Digital outputs (relays):	refer to the label on the device
Fire resistance category:	D
Software class:	A

NOTE: check the power supply rating on the device's label; contact our Sales Department for power and relay ratings.

FURTHER INFORMATION

Input Characteristics

Display range:	See Probes Table
Accuracy:	See Probes Table
Resolution:	See Probes Table
Analogue Inputs:	1 input selectable by parameter H00

Output Characteristics

Digital Outputs:	OUT 1: 1 SPDT 8(3)A max 250 V~ OUT 2: 1 SPDT 8(3)A max 250 V~
Analogue Output*:	Output V/I: 0-1V, 0-5V, 0-10V, 0...20mA e 4...20mA (See Max loads table)
Buzzer output	only on models with provision for buzzer (OPTIONAL)

Mechanical Characteristics

Enclosure:	Plastic casing 4 DIN modules
Dimensions:	front panel 70 x 85, depth 61 mm
Terminals:	screw-type for wires with cross-section of 2.5mm ²
Connectors:	TTL for connection of Unicard/Copy Card + serial port RS-485 for connection to Modbus systems (DR4022 models only)
Humidity:	Operating / Storage: 10...90% RH (non-condensing)

NOTE: The technical specifications stated in this document regarding measurement (range, accuracy, resolution, etc.) refer strictly to the instrument and not to any accessories provided, such as the probes. This means, for example, that the error introduced by the probe must be added to the error of the instrument.

WIRING DIAGRAM DR4020

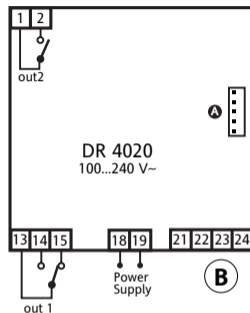
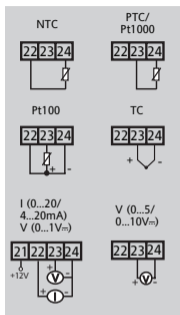
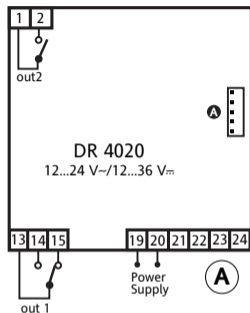

TERMINALS

1-2	N.O. OUT2 relay (see H22)	18-19	Power supply (Model B)
13-14	N.O. OUT1 relay (see H21)	19-20	Power supply (Model A)
13-15	N.C. OUT1 relay (see H21)	21-22-23-24	Probe input
A	TTL for connection to Unicard/ Copy Card or Televis system		

WIRING DIAGRAM DR4020

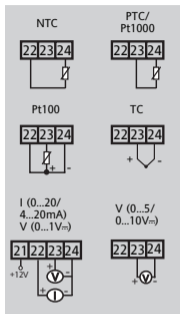

TERMINALS

1-2	N.O. OUT2 relay (see H22)	13-14	N.O. OUT1 relay (see H21)
5-6	Digital Input (D.I.)	13-15	N.C. OUT1 relay (see H21)
7-8-9	Analog Output V/I	18-19	Power supply (Model B)
10-11-12	Serial port RS485	19-20	Power supply (Model A)
A	TTL for connection to Unicard/ Copy Card or Televis system	21-22-23-24	Probe input

MAX LOADS TABLE

* maximum loads that can be driven by the analog output:

output type	permissible load
0-1 V	20mA with minimum load impedance 50 Ohm
0-5 V	20mA with minimum load impedance 250 Ohm
0-10 V	20mA with minimum load impedance 500 Ohm
0-20 mA	350 Ohm
4-20 mA	350 Ohm

PROBES TABLE

Probe*	Range	Probe error limits	Resolution	Accuracy**
NTC	-50...110°C	-55...115°C	0.1°C (0.1°F)	0.5% full scale + 1 digit
PTC	-55...150°C	-60...155°C	0.1°C (0.1°F)	0.5% full scale + 1 digit
Pt1000	-200...800°C	-210...810°C	0.2°F	0.5% full scale + 1 digit
TcJ	-40...760°C	-50...770°C	0.6°C (0.7°F)	0.4% full scale + 1 digit
TcK	-40...1350°C	-50...1360°C	0.6°C (0.7°F)	0.5% full scale + 1 digit
Pt100	-200...800°C	-210...810°C	0.1°C (0.2°F)	0.5% end of scale + 1 digit (over entire scale) 0.2% end of scale + 1 digit (-150...300°C)
V-I***	0 ... 1V 0 ... 5V 0 ... 10V 0 ... 20mA 4 ... 20mA	-1 ... 10% -0.20 ... 10% -0.10 ... 3% 0.05 ... 5% -6.25 ... 6.25%	1 digit with ndt =0 0.1 digit with ndt =1 0.01 digit with ndt =2 0.001 digit with ndt =3	0.5% full scale + 1 digit

* Important! Check the availability of the probes and models.

** The accuracy values shown are valid for an ambient temperature of 25°C

*** The maximum load on the +12V sensor power supply is 60mA

TRANSDUCER CONNECTION EXAMPLES

● EWHS 280 2 fili



● EWHS 300/310-2 3 fili

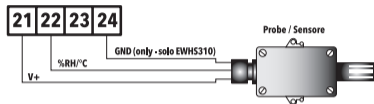

● EWPA 007/030 2 fili

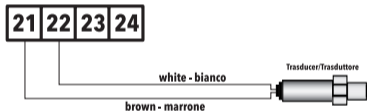

● EWHS 310-2 4 fili

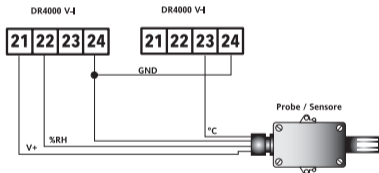

CAUTION: wire colours are guideline. Check the correct connection diagram on the probe label.

ALARMS

Label	Fault	Cause	Effects	Remedy
E1	Probe 1 faulty (Regulation)	<ul style="list-style-type: none"> measured values outside operating range probe faulty/short-circuit/ open-circuit 	<ul style="list-style-type: none"> Label E1 displayed. Alarm icon permanently on Controller disabled max/min alarms Compressor operation on the basis of parameters "On1/2" and "OF1/2". 	<ul style="list-style-type: none"> check probe type (see H00) check probes wiring renew probe
AH1 AH2	Alarm for HIGH Pb1 temperature	<ul style="list-style-type: none"> value read by probe Pb1 > HA1/2 after time "tAO". (see "MAX/MIN TEMPERATURE ALARMS and parameters HA1, HA2, LA1, LA2 and tAO) 	<ul style="list-style-type: none"> Recording of label AH1/HA2 in folder ALAr. No effect on control 	<ul style="list-style-type: none"> Wait for temperature value read by Pb1 to return below HA1/2.
AL1 AL2	Alarm for LOW Pb1 temperature	<ul style="list-style-type: none"> value read by Pb1 < LA1/2 after time "tAO". (see "MAX/MIN TEMPERATURE ALARMS and parameters HA1, HA2, LA1, LA2 and tAO) 	<ul style="list-style-type: none"> Recording of label AL1/AL2 in folder ALAr. No effect on control 	<ul style="list-style-type: none"> Wait for temperature value read by Pb1 to return above LA1/2.
EAL	External Alarm	<ul style="list-style-type: none"> Alarm trip with delay set by parameter H14, in case of activation of digital input (H11=9 or H11=10). 	<ul style="list-style-type: none"> Recording of label EAL in folder ALAr Alarm icon steadily lit. Buzzer and/or relay activation (if configured) Control trip if H11 = 10 	<ul style="list-style-type: none"> check and remove external cause of alarm on D.I.

MAX/MIN TEMPERATURE ALARMS

	Absolute temperature value (Att=0)	Temperature relative to setpoint value (Att=1)
Minimum temperature alarm	Temp. \leq LA1/2 (LA1/2 with sign)	Temp. \leq Set + LA1/2 *
Maximum temperature alarm	Temp. \geq HA1/2 (HA1/2 with sign)	Temp. \geq Set + HA1/2 **
Reset after minimum temperature alarm	Temp. \geq LA1/2 + AFd	Temp. \geq Set + LA1/2 + AFd or \geq Set - LA1/2 + AFd (LA1/2 < 0*)
Reset after maximum temperature alarm	Temp. \leq HA1/2 - AFd	Temp. \leq Set + HA1/2 - AFd (HA1/2 > 0**)
		* if LA1/2 is negative, Set + LA1/2 < Set ** if HA1/2 is negative, Set + HA1/2 < Set

Associated parameters: **Att**, **AFd**, **HA1/2**, **LA1/2**, **PAO**, **SAO**, **tAO** and **AOP**.

CYCLIC CONTROLLER

- Note:**
- **The PERIODIC CYCLE function is selected by pressing a key**
 - **it manages the associated relay output in PWM mode**

This function can be associated with both the relay outputs (by setting parameters **H21** and **H22** =2) and can be used to implement "Duty Cycle" control with the intervals set by parameters **Con** and **CoF**.

CONTROLLER ON-OFF

Model DR4020 and DR4022 has two ON/OFF type controllers that can be configured by the user with parameter H01:

- H01=4, 5 threshold controller
- H01=6 controller with window

HC1	HC2	H01	Type of Setting
H	C	4	independent setpoint
H	C	5	interdependent setpoints
-	-	6	Neutral Zone (or window)

Associated parameters: **SEt1**, **SEt2**, **df1**, **df2**, **db1**, **db2**, **HC1**, **HC2** and **H01**.

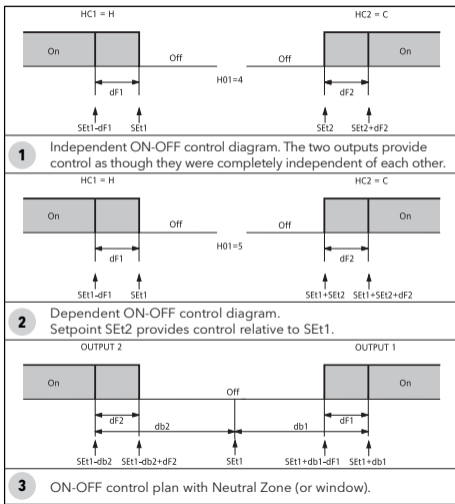

SOFT START CONTROLLER

Note: The SOFT START function is selectable with a key press or by means of a function.

The Soft Start controller can be used to set the temperature gradient over which a given setpoint is reached within a predefined time.

In fact, with this function a gradual increase of the control Setpoint is obtained automatically, from value T_a (ambient temperature at activation) to the value actually set on the display; this allows the initial temperature rise to be slowed and thus reduces overshoot risks.

DUTY-CYCLE REGULATOR

An error condition in the probe causes one of the following actions:

- display shows code **E1**
- controller is activated as indicated by parameters **On1/On2** and **OF1/OF2** if programmed for duty-cycle.

Associated parameters: **On1, On2, OF1 and OF2**

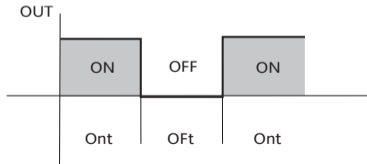

On1	OF1	Controller Output
0	0	OFF
0	>0	OFF
>0	0	ON
>0	>0	Duty Cycle

AUXILIARY CONTROLLER (AUX)

The auxiliary controller can be activated by key press (parameter **H31**=4 o **H32**=4): in this case the controller must be managed as aux by setting parameters **H21(H22)**=4.

This function is used to energise the relay if it was de-energised, or vice versa.

The relay state is stored in order to maintain correct operation in the event of a power failure.

NOTE: The controller is **INACTIVE** during start-up/switch-on (controller OFF) or when in standby (based on the value of H08)

TELEVIS SYSTEM

Televis remote supervision systems can be connected via:

- TTL serial port (use **TTL-RS 485** interface module BUS ADAPTER 130 or 150)
- direct RS-485 connection on models that feature this provision (DR4022).

To configure the instrument for this purpose, open the folder identified by the label "Add" and set **dEA** and **FAA**.

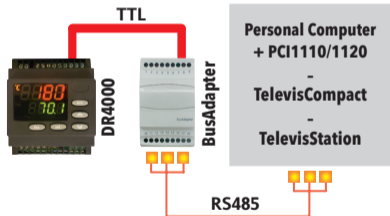

IMPORTANT! CHECK THE AVAILABILITY OF MODELS COMPATIBLE WITH REMOTE SUPERVISION SYSTEMS.

MECHANICAL INSTALLATION and DIMENSIONS

The device is designed for wall or panel mounting on DIN rails. Make a hole 70x45 mm and insert the device, securing it with the fixing hooks provided. Do not install the device in places subject to high humidity and/or dirt; it is intended for use in sites with ordinary or normal levels of pollution. Keep the area around the instrument cooling slots adequately ventilated.

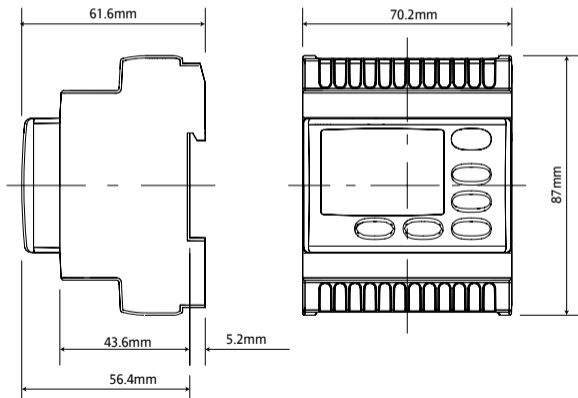

ELECTRICAL CONNECTIONS

Important! Make sure the machine is switched off before working on the electrical connections.

The instrument is equipped with screw-type or plug-in terminal boards for connection of wires having a maximum cross section of 2.5 mm^2 (a single conductor per terminal for the power feeding connections): refer to the label on the instrument for details of the terminal ratings. Do not exceed the maximum permitted current; for higher loads, use a contactor with sufficient power capacity.

Make sure that the power supply is of the correct voltage for the device. Probes have no connection polarity and can be extended using a normal two-core cable (note that extension of the probe leads influences the instrument's electromagnetic compatibility EMC: take great care with the wiring). Probe cables, power supply cables and the TTL serial cable should be routed separately from the mains power cables.

LIABILITY AND RESIDUAL RISKS

ELIWELL CONTROLS SRL declines all liability for damage due to:

- installation/use other than expressly specified and, in particular, in conflict with the safety prescriptions set down in regulations and/or specified in this document
- use on panels that do not provide adequate protection against electric shocks, water or dust in the adopted mounting conditions;
- use on panels allowing access to dangerous parts without having to use tools;
- tampering with and/or modification of the product;
- installation/use on panels that do not comply with statutory laws and regulations.

DISCLAIMER

This document is the exclusive property of ELIWELL CONTROLS SRL and may not be reproduced or circulated without the express permission of ELIWELL CONTROLS.

While all possible care has been taken to ensure the accuracy of this document, ELIWELL CONTROLS SRL cannot accept liability for any damage resulting from its use. The same applies to any person or company involved in preparing and editing this document. ELIWELL CONTROLS SRL reserves the right to make aesthetic or functional changes at any time without notice.

CONDITIONS OF USE

Permitted use

For safety reasons, the device must be installed and used according to the instructions provided. In particular, parts carrying dangerous voltages must not be accessible in normal conditions. The device must be adequately protected from water and dust with regard to the application, and must only be accessible using tools (with the exception of the front panel). The device is suitable for use in household refrigeration appliances and/or similar equipment and has been tested for safety aspects in accordance with the harmonised European reference standards.

Improper use

Any use other than that expressly permitted is prohibited. The relays provided are of a functional type and can be subject to failure: any protection devices required by product standards, or suggested by common sense for obvious safety requirements, must be installed externally to the controller.



Eliwell Controls s.r.l.

Via dell'Industria, 15 • Z.I. Paludi
32010 Pieve d'Alpago (BL) ITALY
Telephone +39 0437 986 111
Fax +39 0437 989 066
www.eliwell.it

Technical Customer Support:

Technical helpline +39 0437 986 300
E-mail: techsuppeliwell@invensys.com

Sales

Telephone +39 0437 986 100 (Italy)
+39 0437 986 200 (other countries)
E-mail: saleseliwell@invensys.com

code 9IS54203-1 - DR4000 - EN - rel. 03/11

© **Eliwell Controls s.r.l. 2011 All rights reserved.**



ISO 9001



i n v e n s y s
Controls